

***MF SERIES***  
***Mini-Flowmeters***  
***for Low Flow Applications***

**USER'S MANUAL**



**HP-210**  
**September 2019**

***HOFFER***  
***Flow Controls***

**Perfecting Measurement™**

107 Kitty Hawk Lane • P.O. Box 2145 • Elizabeth City, NC 27909  
1-800-628-4584 • (252) 331-1997 • Fax (252) 331-2886  
www.hofferflow.com      email: info@hofferflow.com



---

# NOTICE

---

Hoffer Flow Controls, Inc. makes no warranty of any kind with regard to this material, including, but not limited to, the implied warranties of merchantability and fitness for a particular purpose.

This manual has been provided as an aid in installing, connecting, calibrating, operating, and servicing this unit. Every precaution for accuracy has been taken in the preparation of this manual; however, Hoffer Flow Controls, Inc. neither assumes responsibility for any omissions or errors that may appear nor assumes liability for any damages that result from the use of the products in accordance with information contained in the manual.

HOFFER FLOW CONTROLS' policy is to provide a user manual for each item supplied. Therefore, all applicable user manuals should be examined before attempting to install or otherwise connect a number of related subsystems.

During installation, care must be taken to select the correct interconnecting wiring drawing. The choice of an incorrect connection drawing may result in damage to the system and/or one of the components.

Please review the complete model number of each item to be connected and locate the appropriate manual(s) and/or drawing(s). Identify all model numbers exactly before making any connections. A number of options and accessories may be added to the main instrument, which is not shown on the basic user wiring. Consult the appropriate option or accessory user manual before connecting it to the system. In many cases, a system wiring drawing is available and may be requested from Hoffer Flow Controls.

This document contains proprietary information, which is protected by copyright. All rights are reserved. No part of this document may be photocopied, reproduced, or translated to another language without the prior written consent of Hoffer Flow Controls, Inc.

HOFFER FLOW CONTROLS' policy is to make running changes, not model changes, whenever an improvement is possible. This affords our customers the latest in technology and engineering. The information contained in this document is subject to change without notice.

THIS WARRANTY IS EXPRESSLY IN LIEU OF ALL OTHER WARRANTIES, EXPRESSED OR IMPLIED, INCLUDING ANY IMPLIED WARRANTY OF MERCHANTABILITY OR FITNESS FOR A PARTICULAR PURPOSE. HFC SHALL NOT BE LIABLE FOR ANY LOSS OR DAMAGE RESULTING, DIRECTLY OR INDIRECTLY, FROM THE USE OR LOSS OF USE OF THE GOODS. WITHOUT LIMITING THE GENERALITY OF THE FOREGOING, THIS EXCLUSION FROM LIABILITY EMBRACES THE PURCHASER'S EXPENSES FOR DOWNTIME OR FOR MAKING UP DOWNTIME, DAMAGES FOR WHICH THE PURCHASER MAY BE LIABLE TO OTHER PERSONS, DAMAGES TO PROPERTY, AND INJURY TO OR DEATH OF ANY PERSONS. HFC NEITHER ASSUMES NOR AUTHORIZES ANY PERSON TO ASSUME FOR IT ANY OTHER LIABILITY IN CONNECTION WITH THE SALE OR USE OF HFC'S GOODS, AND THERE ARE NO ORAL AGREEMENTS OR WARRANTIES COLLATERAL TO OR AFFECTING THE AGREEMENT. *PURCHASER'S SOLE AND EXCLUSIVE REMEDY IS THE REPAIR AND/OR REPLACEMENT OF NONCONFORMING GOODS AS PROVIDED IN THE PRECEDING PARAGRAPHS. HFC SHALL NOT BE LIABLE FOR ANY OTHER DAMAGES WHATSOEVER INCLUDING INDIRECT, INCIDENTAL, OR CONSEQUENTIAL DAMAGES.*

---

## LIMITED WARRANTY POLICY FOR HOFFER FLOW CONTROLS

---

HOFFER FLOW CONTROLS, INC. ("HFC") warrants HFC's Precision Series, API Series and CT Series of turbine flowmeters to be free from defects in material and workmanship under normal use and service, only if such goods have been properly selected for the service intended, properly installed and properly operated and maintained as described in the turbine flowmeter manual. Reference "turbine flowmeter manual" for specific details. This warranty shall extend for a period of five (5) years from the date of shipment to the original purchaser and covers the Precision Series and API Series of flowmeters supplied with their standard hybrid ceramic ball bearings only. All other HFC products carry a one (1) year warranty. This warranty is extended only to the original purchaser ("Purchaser"). *Purchaser's sole and exclusive remedy is the repair and/or replacement of nonconforming goods as provided in the following paragraphs.*

In the event Purchaser believes the Hoffer product is defective, the product must be returned to HFC, transportation prepaid by Purchaser, within the appropriate warranty period relative to the product. If HFC's inspection determines that the workmanship or materials are defective and the required maintenance has been performed and, has been properly installed and operated, the product will be either repaired or replaced, at HFC's sole determination, free of additional charge, and the goods will be returned, transportation paid by HFC, using a transportation method selected by HFC.

Prior to returning the product to HFC, Purchaser must obtain a Returned Material Authorization (RMA) Number from HFC's Customer Service Department within 30 days after discovery of a purported breach of warranty, but not later than the warranty period; otherwise, such claims shall be deemed waived. See the Return Requests/inquiries Section of this manual.

If HFC's inspection reveals the Hoffer product to be free of defects in material and workmanship or such inspection reveals the goods were improperly used, improperly installed, and/or improperly selected for service intended, HFC will notify the purchaser in writing and will deliver the goods back to Purchaser upon receipt of Purchaser's written instructions and agreement to pay the cost of transportation. If Purchaser does not respond within thirty (30) days after notice from HFC, the goods will be disposed of in HFC's discretion.

HFC does not warrant the product to meet the requirements of any safety code of any state, municipality, or other jurisdiction, and Purchaser assumes all risk and liability whatsoever resulting from the use thereof, whether used singly or in combination with other machines or apparatus.

This warranty shall not apply to any HFC product or parts thereof, which have been repaired outside HFC's factory or altered in any way, or have been subject to misuse, negligence, or accident, or have not been operated in accordance with HFC's printed instructions or have been operated under conditions more severe than, or otherwise exceeding, those set forth in the specifications.

---

FOR **NON-WARRANTY** REPAIRS OR **CALIBRATIONS**, consult HOFFER FLOW CONTROLS for current repair/calibration charges. Have the following information available BEFORE contacting HOFFER FLOW CONTROLS:

1. P.O. number to cover the COST of the repair/calibration,
  2. Model and serial number of the product, and
  3. Repair instructions and/or specific problems relative to the product.
-

# CONTENTS

1.	Introduction.....	1
1.1	Model Number Designation.....	2
1.2	Specification.....	7
2.	Operation.....	9
2.1	Principle.....	9
2.2	Precautions.....	9
3.	Installation.....	11
3.1	General Piping.....	11
3.2	Strainers/Filters.....	12
3.3	Installation Kits.....	12
4.	Maintenance.....	13
4.1	General.....	13
4.2	Disassembly.....	13
4.3	Inspection & Repair.....	13
4.4	Assembly.....	15
4.5	Pickup Coil Testing.....	15
4.6	Trouble Shooting.....	17
4.7	Spare Parts.....	18



# 1 Introduction

We are proud that you have selected a Hoffer Turbine Mini-Flowmeter, the finest precision flow transducer on the market.

The Hoffer MF Series of Mini-Flowmeters are designed to meet the need for a high quality low flow measurement device for service in low to moderate viscosity clean liquids and for gas applications.

The information in this manual is provided to assist in the proper installation, use, and maintenance of your instrument.

Please take a few minutes to read through this manual before installing and operating your meter. If you have any problems with the meter, refer to the maintenance and troubleshooting sections of this manual.

If you need further assistance, contact your local Hoffer Representative or contact the Hoffer Flow Controls customer service department by telephone, fax, or email for advice.

We welcome you to our growing family of satisfied customers. If you are not completely satisfied with either our product or service, we encourage you to let us know. We want to improve!

### 1.1 Model Number Designation

The model number of the meter describes various fittings and options.

#### MINI-FLOWMETER SERIES FOR LIQUID

MODEL MF1/2X(A)-(B)-(C)-(D)-(E/F)-(MS)-(G)

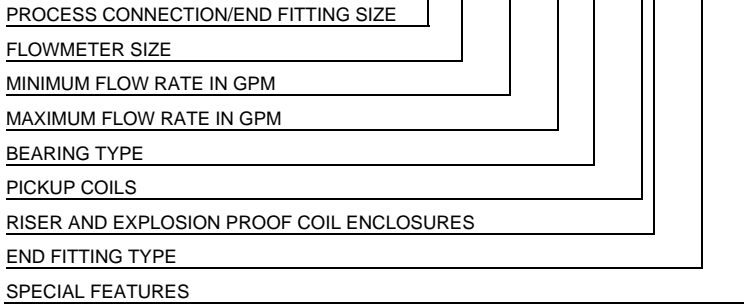

#### PROCESS CONNECTION

ALL MINI-FLOWMETERS ARE 1/2", 37 DEG. MALE FLARE PER MS33656

MODEL MF1/2X(A)-( )-( )-( )-( / )-( )-( )

END FITTING X (A)

- MF1/2X20B
- MF1/2X30B
- MF1/2X40B
- MF1/2X50B
- MF1/2X60B
- MF1/2X70B
- MF1/2X80B
- MF1/2X90B
- MF1/2X100B
- MF1/2X125B
- MF1/2X150B
- MF1/2X175B

#### MINIMUM FLOW AND MAXIMUM FLOW RATE IN GPM (LINEAR RANGE)

MODEL MF1/2X( )-(B)-(C)-( )-( / )-( )-( )

(B) <u>FLOWMETER SIZE</u>	(C) <u>MINIMUM FLOW</u>	TO	<u>MAXIMUM FLOW</u>
MF20	.015 GPM		.049 GPM
MF30	.017 GPM		.120 GPM
MF40	.020 GPM		.150 GPM
MF50	.023 GPM		.2 GPM
MF60	.025 GPM		.25 GPM
MF70	.050 GPM		.5 GPM
MF80	.075 GPM		.75 GPM
MF90	.085 GPM		.85 GPM
MF100	.1 GPM		1 GPM
MF125	.13 GPM		1.3 GPM
MF150	.2 GPM		2 GPM
MF175	.3 GPM		3 GPM



**BEARING TYPE**

MODEL MF1/2X( )-( )-( )-(D)-( / )-( )-( )  
 TURBINE SIZES OPTION ( D )

MF1/2X20B	(PB) (C) (T)	CERAMIC HYBRID BALL BEARING, SELF LUBRICATING HARD CARBON COMPOSITE SLEEVE BEARING TUNGSTEN CARBIDE SLEEVE BEARING
MF1/2X30B	(BP) (C) (T)	CERAMIC HYBRID BALL BEARING, SELF LUBRICATING HARD CARBON COMPOSITE SLEEVE BEARING TUNGSTEN CARBIDE SLEEVE BEARING
MF1/2X40B	(BP) (C) (T)	CERAMIC HYBRID BALL BEARING, SELF LUBRICATING HARD CARBON COMPOSITE SLEEVE BEARING TUNGSTEN CARBIDE SLEEVE BEARING
MF1/2X50B	(BP)	CERAMIC HYBRID BALL BEARING, SELF LUBRICATING
MF1/2X60B	(C)	HARD CARBON COMPOSITE SLEEVE BEARING
MF1/2X70B	(T)	TUNGSTEN CARBIDE SLEEVE BEARING
MF1/2X80B	(BP)	CERAMIC HYBRID BALL BEARING, SELF LUBRICATING
MF1/2X90B	(C)	HARD CARBON COMPOSITE SLEEVE BEARING
MF1/2X100B	(T)	TUNGSTEN CARBIDE SLEEVE BEARING
MF1/2X125B		
MF1/2X150B		
MF1/2X175B		

**PICKUP COILS**

MODEL MF1/2X( )-( )-( )-( )-(E/ )-( )-( )

OPTION ( E )

(1M)	ONE MAG COIL
(1MC3PA)	ONE RF COIL
(1MC2PAHT)	ONE HIGH TEMP RF COIL
(1HTM)	HIGH TEMP MAG COIL
(1ISM)	ONE INTRINSICALLY SAFE MAG COIL, NORTH AMERICA
(1ISM-ATEX)	ONE ISM ATEX COIL
(1RPMXXX)	ONE REDI-PULSE MAG COIL
(1RPRXXX)	ONE REDI-PULSE RF COIL
(1DMXXXX)	ONE REDI-PULSE INTRINSICALLY SAFE MAG COIL
(1DRXXX)	ONE REDI-PULSE INTRINSICALLY SAFE RF COIL
(-ATEX)*	WHEN ANY COIL IS GOING TO HAVE AN ATEX ENCLOSURE MOUNTED ON THE FLOWMETER ADD (-ATEX) AFTER THE COIL PART NUMBER. (THE COIL NEEDS TO BE MODIFIED TO FIT INTO A 3/4" RISER WELDED TO THE BODY REQUIRED BY ATEX)
	<u>*OPTIONAL SPECIAL TOOL</u> IN ORDER TO REPLACE THE COIL IN THE FIELD, A SPECIAL WRENCH IS REQUIRED TO REPLACE THE COIL.
(-P*)	PIGTAIL OR FLYING LEADS, ADD -P AND THE *LENGTH OF LEADS AFTER ANY COIL EXCEPT THE HIGH TEMPERATURE COILS.

**RISER AND EXPLOSION PROOF COIL ENCLOSURES**

MODEL MF1/2X( )-( )-( )-( )-( /E)-( )-( )

OPTION ( F )

**RISER FOR STANDARD MODELS AND Ex d CERTIFIED SYSTEMS**

- (X) 1" MNPT RISER, WELDED TO BODY
- (X-ATEX) 3/4" MNPT RISER, WELDED TO BODY
- X-ATEX)E2\* 3/4" MNPT RISER WITH E2 ENCLOSURE\*\*

**RISER FOR STANDARD MODELS ONLY (NOT FOR USE WITH Ex d SYSTEMS)**

- (XE2)\* 1" MNPT RISER WITH E2 ENCLOSURE\*\*  
INCLUDES STOCK #300-8375 1"X3/4" ADAPTER
- (X8S) 8" LONG S/S 1" MNPT RISER  
FOR FLUID TEMPERATURES BELOW-40°F (-40°C) OR ABOVE +158°F (+70°C)
- (X8S-ATEX) 8" LONG S/S 3/4" MNPT RISER FOR FLUID TEMPERATURES BELOW-40°F (-40°C) OR ABOVE +158°F (+70°C)

**\*OPTIONS FOR ENCLOSURE STYLE E2**

(\_S) STAINLESS STEEL ENCLOSURE (ONLY RATED FOR ATEX/IECEX)

**\*\*NOTES: EXPLOSION-PROOF/FLAME-PROOF ENCLOSURE WITH 3/4" FNPT MOUNT AND 3/4" CABLE ENTRY**

- FM: CLASS I, DIV. 1, GR. ABCD, CLASS II/III, DIV. 1, GR. EFG, TYPE 4X
- CSA: CLASS I, DIV. 1, GR. ABCD, CLASS II, DIV 1, GR. EFG, CLASS III, TYPE 4X EX D IIC, CLASS I, ZONE 1, IP 66
- ATEX: EX II 2GD Ex d tD IIC, IP66/68
- IEC: EX D IIC IP68

**FOR UL LISTED ENCLOSURE CONTACT FACTORY**

**PROCESS CONNECTION/END FITTING TYPE**

MODEL MF1/2X( )-( )-( )-( )-( / )-(MS)-( )

OPTION

- (MS) ALL MINI-FLOWMETERS ARE 1/2", 37 DEG. MALE FLARE PER MS33656
- (1/4-TS) 1/4" TUBE STUB
- (1/2-TS) 1/2" TUBE STUB
- (NPT) 1/2" MALE NPT

**SPECIAL FEATURES**

MODEL MF1/2X( )-( )-( )-( )-( / )-( )-(G)

OPTION ( G )

- (6W ) HIGH PRESSURE UNITS, OVER 1000 PSIG TO MAX OF 6000 PSIG\*
- (6CW) CRYOGENIC SERVICE  
RATED TO 6000 PSIG AND CLEANED FOR LOX SERVICE\*
- (CE) CE MARK REQUIRED FOR EUROPE
- (PED-CE) PED REQUIRES THAT BOTH THE OPERATING PRESSURE AND TEMPERATURE MUST BE KNOWN AND ENTERED ON THE ORDER. THIS INFORMATION WILL BE MARKED ON THE HOUSING TO MEET PED REQUIREMENTS.
- (SEP-CE) SOUND ENGINEERING PRACTICE.
- (SP) ANY SPECIAL FEATURES THAT ARE NOT COVERED IN THE MODEL NUMBER, USE A WRITTEN DESCRIPTION OF THE -SP.  
\*WELDED CAP-MINI MUST BE RETURNED TO THE FACTORY FOR REPAIR – **NOT FIELD REPAIRABLE.**

**MINI-FLOWMETER SERIES FOR GAS**

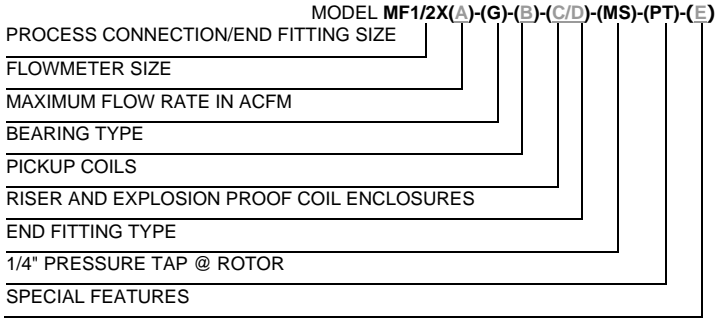

**PROCESS CONNECTION**

ALL MINI-FLOWMETERS ARE 1/2", 37 DEG. MALE FLARE PER MS33656

MODEL MF1/2X(A)-( )-( )-( / )-( )-( )

END FITTING X (A)

- MF1/2X30B
- MF1/2X50B
- MF1/2X80B
- MF1/2X90B
- MF1/2X125B
- MF1/2X175B

**MAXIMUM FLOW RATE IN ACFM**

MODEL MF1/2X( )-(G)-( )-( / )-( )-( )

OPTION

( G )                      RATE IS DETERMINED BY THE GAS SIZING PROGRAM BY SALES

**BEARING TYPE**

MODEL MF1/2X( )-( )-(B)-( / )-( )-( )

TURBINE SIZES    OPTION ( B )

- MF1/2X30B    (BP)    CERAMIC HYBRID BALL BEARING, SELF LUBRICATING
- MF1/2X50B    (BP)    CERAMIC HYBRID BALL BEARING, SELF LUBRICATING
- MF1/2X80B    (BP)    CERAMIC HYBRID BALL BEARING, SELF LUBRICATING
- MF1/2X90B    (BP)    CERAMIC HYBRID BALL BEARING, SELF LUBRICATING
- MF1/2X125B
- MF1/2X175B

**PICKUP COILS**

MODEL MF1/2X( )-( )-( )-( C / )-( )-( )-( )

OPTION ( C )

- (1M) ONE MAG COIL
- (1MC3PA) ONE RF COIL
- (1MC2PAHT) ONE HIGH TEMP RF COIL
- (1ISM) ONE INTRINSICALLY SAFE MAG COIL, NORTH AMERICA
- (1ISM-ATEX) ONE ISM ATEX COIL
- (1RPRXXX) ONE REDI-PULSE RF COIL
- (1DRXXXX) ONE REDI-PULSE INTRINSICALLY SAFE RF COIL
- (-ATEX)\* WHEN ANY COIL IS GOING TO HAVE AN ATEX ENCLOSURE MOUNTED ON THE FLOWMETER ADD (-ATEX) AFTER THE COIL PART NUMBER. **(THE COIL NEEDS TO BE MODIFIED TO FIT INTO A 3/4" RISER WELDED TO THE BODY REQUIRED BY ATEX)**
- \*OPTIONAL SPECIAL TOOL  
IN ORDER TO REPLACE THE COIL IN THE FIELD, A SPECIAL WRENCH IS REQUIRED TO REPLACE THE COIL.
- (-P\*) PIGTAIL OR FLYING LEADS, ADD -P AND THE \*LENGTH OF LEADS AFTER ANY COIL EXCEPT THE HIGH TEMPERATURE COILS.

**RISER AND EXPLOSION PROOF COIL ENCLOSURES**

MODEL MF1/2X( )-( )-( )-( / D )-( )-( )-( )

OPTION ( D )

**RISER FOR STANDARD MODELS AND Ex d CERTIFIED SYSTEMS**

- (X) 1" MNPT RISER, WELDED TO BODY
- (X-ATEX) 3/4" MNPT RISER, WELDED TO BODY
- (X-ATEX)E2\* 3/4" MNPT RISER WITH E2 ENCLOSURE\*\*

**RISER FOR STANDARD MODELS AND Ex d CERTIFIED SYSTEMS**

- (XE2)\* 1" MNPT RISER WITH E2 ENCLOSURE\*\*  
INCLUDES STOCK #300-8375 1"X3/4" ADAPTER
- (X8S) 8" LONG S/S 1" MNPT RISER  
FOR FLUID TEMPERATURES BELOW-40°F (-40°C) OR ABOVE +158°F (+70°C)
- (X8S-ATEX) 8" LONG S/S 3/4" MNPT RISER  
FOR FLUID TEMPERATURES BELOW-40°F (-40°C) OR ABOVE +158°F (+70°C)

**OPTIONS FOR ENCLOSURE STYLE E2**

( S ) STAINLESS STEEL ENCLOSURE (ONLY RATED FOR ATEX/IECEX)

**\*\*NOTES: EXPLOSION-PROOF/FLAME-PROOF ENCLOSURE WITH 3/4" FNPT MOUNT AND 3/4" CABLE ENTRY**

- FM: CLASS I, DIV. 1, GR. ABCD, CLASS II/III, DIV. 1, GR. EFG, TYPE 4X
- CSA: CLASS I, DIV. 1, GR. ABCD, CLASS II, DIV 1, GR. EFG, CLASS III, TYPE 4X EX D IIC, CLASS I, ZONE 1, IP 66
- ATEX: EX II 2GD Ex d tD IIC, IP66/68
- IEC: EX D IIC IP68

**FOR UL LISTED ENCLOSURE CONTACT FACTORY**

**PROCESS CONNECTION/END FITTING TYPE**

MODEL MF1/2X( )-( )-( )-( )-( / )-(MS)-( )-( )

OPTION

(MS) ALL MINI-FLOWMETERS ARE 1/2", 37 DEG. MALE FLARE PER MS33656  
 (1/4-TS) 1/4" TUBE STUB  
 (1/2-TS) 1/2" TUBE STUB  
 (NPT) 1/2" MALE NPT

**PRESSURE TAP @ ROTOR**

MODEL MF1/2X( )-( )-( )-( )-( / )-( )-(PT)-( )

OPTION

(PT) 1/4" PRESSURE TAP @ ROTOR

**SPECIAL FEATURES**

MODEL MF1/2X( )-( )-( )-( )-( / )-( )-( )-(E)

OPTION (E)

(6W) HIGH PRESSURE UNITS, OVER 1000 PSIG TO MAX OF 6000 PSIG\*  
 (6CW) CRYOGENIC SERVICE RATED TO 6000 PSIG AND CLEANED FOR LOX SERVICE.\*  
 (CE) CE MARK REQUIRED FOR EUROPE (PED-CE)  
 (PED-CE) PED REQUIRES THAT BOTH THE OPERATING PRESSURE AND TEMPERATURE MUST BE KNOWN AND ENTERED ON THE ORDER. THIS INFORMATION WILL BE MARKED ON THE HOUSING TO MEET PED REQUIREMENTS.  
 (SEP-CE) SOUND ENGINEERING PRACTICE  
 (SP) ANY SPECIAL FEATURES THAT ARE NOT COVERED IN THE MODEL NUMBER, USE A WRITTEN DESCRIPTION OF THE -SP.

\*WELDED CAP-MINI MUST BE RETURNED TO THE FACTORY FOR REPAIR – **NOT FIELD REPAIRABLE.**

**1.2 Specification**Linearity:  $\pm 1.0\%$  of reading over 10:1 flow rangeRepeatability:  $\pm 0.25\%$  of reading

Flow Ranges:

Liquid Applications: 0.02 to 3.5 GPM w/ MAG pickup in 10:1 turndown  
 0.007 to 3.5 GPM w/ MCP pickup in 25:1 turndown  
 Gas Applications: 0.005 to 1 ACFM w/ MCP pickup; turndown  
 dependent on gas density

Temperature Range: -450 °F to +450 °F

Output: Dependent on pickup coil selected

This page intentionally left blank.

## 2 Operation

### 2.1 Principle

The Hoffer MF Series has been developed to meet the need for a low flow measurement device for use with low to moderate viscosity clean liquids and for gas measurement applications.

The MF Series is a family of low flow rate measurement devices whose design is based on a Pelton Wheel-like rotor. The measured fluid is directed tangentially through a velocity nozzle against the rotor causing it to spin. The pickup coil senses the spinning motion of the rotor through the housing and converts it into a pulsing electrical signal. Summation of the pulsing electrical signal relates directly to the total flow, while the frequency is related to the flow rate.

### 2.2 Precautions

- ◆ Do not drop the meter. Dropping the meter may result in damage to the meter housing and/or internals.
- ◆ Do not operate the meter at flowrates greater than the maximum flowrate marked on the meter. Operating at flowrates greater than the maximum flowrate may over-spin the meter. Over-spinning may result in damage to the meter.

**CAUTION:** *Avoid over-spinning the meter. Over-spinning the meter may result in damage to the meter internals and lead to meter failure.*

This page intentionally left blank.



### 3 Installation

Upon receipt of the flowmeter carefully inspected it, checking for any indications of damage which may have occurred during shipment. Inspect all packing material carefully for parts or components which may have been packed with the shipment. Refer to the packing list/invoice for a detailed list of items included in the shipment.

#### 3.1 General Piping

The MF Series Flowmeters are capable of sensing fluid flow in one direction only. The meter housing is marked by a flow direction arrow to indicate the direction of flow through the meter. The meter must be installed in the piping in the correct orientation to ensure the most accurate and reliable operation. Care should be taken in the proper selection of the mating fittings. Size, type of material, and pressure rating should be the same as the flowmeter supplied.

When it is expected that flow will be intermittent, the meter should not be mounted at a low point in the piping system. Solids which settle or congeal in the meter may affect meter performance.

In order to achieve optimum electrical signal output from the flowmeter, due consideration must be given to its isolation from ambient electrical interference such as nearby motors, transformers, and solenoids.

A typical flowmeter installation is shown below:

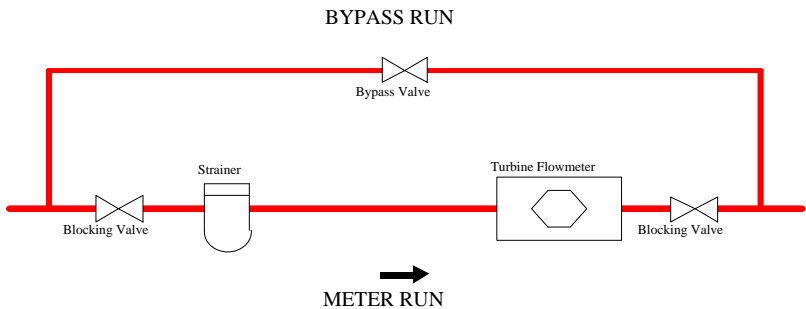

Blocking and Bypass valves should be installed if it is necessary to do preventive maintenance on the flowmeter without shutting down the flow system. The Bypass valve can be opened before the Blocking valves are closed allowing the flow to continue while removing the turbine flowmeter for service.

## 12 Installation

---

**IMPORTANT:** *All flow lines should be purged prior to installing the meter. To prevent possible damage to the meter, install the meter **ONLY** in flow lines that are clean and free of debris.*

---

Upon initial start-up of the system a spool piece should be installed in place of the flowmeter so that purging of the system can be performed to remove all particle debris which could cause damage to the meter internals. In applications where meter flushing is required after meter service, care should be taken as to not over-spin the meter, as severe meter damage may occur.

**CAUTION:** *Avoid over-spinning the meter. Over-spinning the meter may result in damage to the meter internals and lead to meter failure.*

### 3.2 Strainers/Filters

The MF Series flowmeters are designed for use in a clean fluid service. However, the service fluid may carry some particulate material which would need to be removed before reaching the flowmeter. Under these conditions a strainer/filter may be required to reduce the potential hazard of fouling or damage that may be caused by foreign matter.

METER SIZE	MESH SIZE	PARTICLE SIZE (Maximum)
MF Series	100	.0055
¼" to ½"	100	.0055
⅝" to 1¼"	70	.008
1½" to 3"	40	.015

If a strainer/filter is required in the system, it should be located upstream of the flowmeter taking care that the proper minimum distance is kept between the strainer and flowmeter.

### 3.3 Installation Kits

Installation kits for the Hoffer MF Series Flowmeter consist of two lengths of appropriate tubing cut to a length appropriate for the upstream and downstream straight pipe run with appropriate end fittings.

## 4 Maintenance

### 4.1 General

Preventive maintenance for the MF Series mini-flowmeter consists of a thorough general inspection. Remove the meter from the service line and take to a clean work area. Use the following procedures and exploded component views to remove, inspect, and reinsert the flowmeter internals.

### 4.2 Disassembly

1. Hold the Mini-Flowmeter securely using a vise. Meter orientation should be such that the threaded plug is facing up. Use extreme care not to damage the meter housing or piping connections when placing in the vise.
2. Using a large-blade screwdriver, turn the plug counterclockwise to remove.
3. To remove the shaft assembly, carefully thread a 10-32 screw into the hole provided in insert. Thread the screw into the insert until it bottoms out (finger tight only).
4. Turn the housing over and slowly and carefully pull the shaft assembly and internals out of the housing. Take care not to damage the shaft, rotor, and/or bearings.
5. Remove and discard the gasket/seal.

### 4.3 Inspection & Repair

1. Examine the flowmeter internals for signs of corrosion or fouling by foreign materials.
2. Examine the shaft, rotor, and bearings for signs of wear and/or damage.
3. If wear or damage is present, replace with new parts.

---

**NOTE:** *Clean all of the internals in an approved cleaning solution.*

---

# 14 Maintenance

## Exploded View: BB - Ball Bearing Models

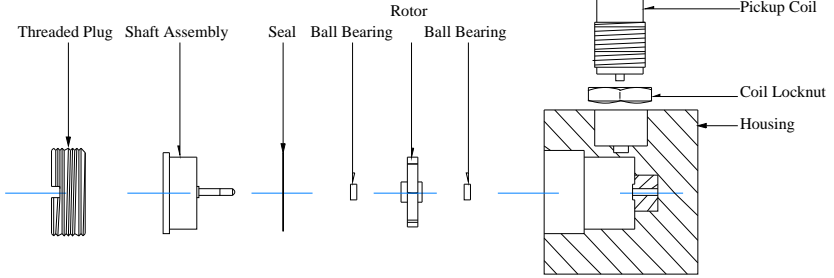

## Exploded View: C - Hard Carbon Bearing Models

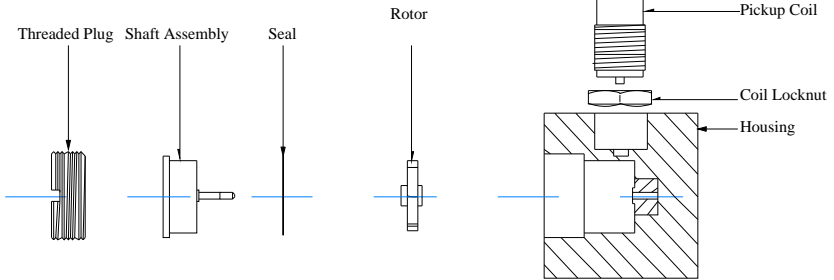

## Exploded View: TC - Tungsten Carbide Sleeve Models

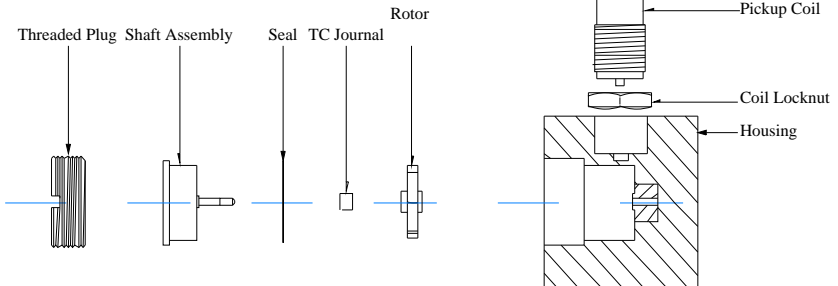

## 4.4 Assembly

1. Install any new parts.
2. Guide the rotor and bearing assembly onto the shaft. Make sure the rotor is installed with the cup side of the Pelton wheel facing the "IN" side of the housing.
3. Place a new gasket on the insert. *Always use a new gasket.*
4. Place the shaft assembly insert, gasket, and rotor assembly back into housing by inverting the housing to keep gasket and rotor assembly in place.
5. Install the threaded plug and tighten to 50 ft-lb.

## 4.5 Pickup Coil Testing

Testing the MAG and MCP (RF) coils consists of measuring the resistance with an ohmmeter. Resistance measurements are to be made when there is no flow through the meter or with the coil removed from the meter housing.

1. Measure the resistance between pin A and pin B. The resistance should be approximately as listed in the following table of some common coils.
2. The resistance from any pin to the case should be greater than 1 Mohm.

COIL*	DC RESISTANCE (Ohms)
MC2PAHT	15.0 ±10%
MCP3A	11.5 ±10%
PC13-74G	1800 ±10%
PC13-74S	1850 ±15%
PC24-45G	1350 ±10%
PC24-45S	1850 ±15%
PC28-13G	120 ±20%
PC28-14G	180 ±20%

---

\* For specific coils not listed contact the HFC Customer Service Department for the approximate resistance readings.

If either resistance measurement fails, replace the pickup coil. Firmly seat the new coil in the flowmeter and tighten the locking nut.

### Pickup Connections

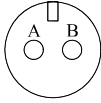

MAG

---

A - Signal (+)  
B - Common (-)

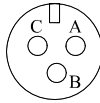

MCP (RF)

---

A - Signal (+)  
B - Common (-)  
C - N/C

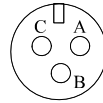

RediPulse

---

A - 8 - 30 Vdc  
B - Common (-)  
C - Pulse Output

## 4.6 Troubleshooting

Refer to the following troubleshooting guide for assistance with possible meter malfunctions:

TROUBLE	CAUSE	REMEDY
Fluid will not flow through the meter	<ul style="list-style-type: none"> <li>▪ Meter clogged.</li> <li>▪ Line to meter blocked.</li> </ul>	Clear meter. Clear line to meter.
Reduced flow through the meter	<ul style="list-style-type: none"> <li>▪ Meter partially clogged.</li> <li>▪ Line to meter partially blocked.</li> </ul>	Clear meter. Clear line to meter.
Meter readings inaccurate	<ul style="list-style-type: none"> <li>▪ Fluid flowrate is not within meter flow range.</li> <li>▪ Meter drag due to worn or damaged parts.</li> </ul>	See “Specifications” for min and max flowrates. Replace worn or damaged parts.
Meter not giving pulse signal	<ul style="list-style-type: none"> <li>▪ Faulty pickup coil.</li> <li>▪ Meter internals not turning due to worn or damaged parts.</li> </ul>	Replace pickup coil. Replace worn or damaged parts.

## 4.7 Spare Parts

The following table contains the suggested spare parts for the Hoffer MF Series flowmeters:

Item No.	Qty	Part No.	Part Description
1	1	300-#### <sup>1</sup>	Pickup Coil
1	1	300-#### <sup>2</sup>	Seal/Gasket
1	1	300-#### <sup>2</sup>	Rotor Assembly
1	1	300-#### <sup>2</sup>	Bearings
1	1	300-#### <sup>2</sup>	Shaft Assembly

Specific meter parts are dependent upon the meter size and model, always have the complete meter model number or serial number available when consulting the factory.

---

<sup>1</sup> Specific pick-up coil is application dependent. Consult with the factory for the correct part number. Have complete meter model number or pick-up coil model number available.

<sup>2</sup> Meter internals are ordered by the size of the meter. Consult with the factory for the correct part number. Have complete meter model number available.